

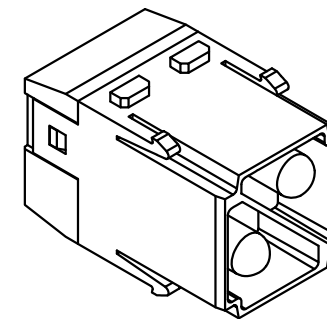

Technical data:

- No. of contact: 2
- Termination method: Axial screw termination
- Gender: Male
- Conductor cross-section: 16 ... 35 mm²
- Rated current: 100A
- Rated voltage: 1000V
- Rated impulse voltage: 8kV
- Pollution degree: 3
- Rated voltage acc.to UL: 600V
- Insulation resistance: $\geq 10^{10}\Omega$
- Contact resistance: $\leq 0.3m\Omega$
- Stripping length: 12 ... 14mm
- Tightening torque: 6 ... 8Nm
- Limiting temperature: -40 ... +125°C
- Material(insert): Polycarbonate
- Color(insert): RAL 7032(pebble grey)
- Material(contacts): Copper alloy
- Surface(contacts): Silver plated
- Mating cycles: ≥ 500
- Material flammability class acc. to UL94: V-0
- RoHS: Compliant
- Specifications: IEC61984, EN60664-1

技术数据:

- 针数: 2
- 接线方式: 轴向螺钉连接
- 公母类型: 公头
- 导体截面积: 16 ... 35 mm²
- 额定电流: 100A
- 额定电压: 1000V
- 额定脉冲电压: 8kV
- 污染等级: 3
- 额定电压符合UL: 600V
- 绝缘阻抗: $\geq 10^{10}\Omega$
- 接触电阻: $\leq 0.3m\Omega$
- 剥线长度: 12 ... 14mm
- 拧紧力矩: 6 ... 8Nm
- 极限温度: -40 ... +125°C
- 材料(插芯): 聚碳酸酯
- 颜色(插芯): RAL 7032(卵石灰)
- 材料(插针): 铜合金
- 表面(插针): 镀银
- 插拔次数: ≥ 500
- 材料阻燃性等级符合UL94: V-0
- RoHS: 符合豁免标准
- 规格: IEC61984, EN60664-1



 InKonn [®] InKonn (Suzhou) Electric Technology Co.,Ltd.	 All Dimensions in mm Original Size DIN A4	Date 2022-4-19	Drawing No. TC1073152	Rev. A00	Scale 1:1
	Part No. 10 38 002 1101	Created by Shuxu Huang	Checked by Yiyi Luo	Page 1/1	
Type Name I2M100-002.2-M					